

Portable air purifier
OiSHi
CT-OS01

ataraina

Instruction Manual

Includes warranty

Table of Contents

1. Safety Precautions	P.2
2. Product Overview	P.4
3. Operation	P.5
Before using the Aroma Capsule	P.8
4. Specifications	P.9
5. Cleaning	P.9
6. Troubleshooting	P.10
7. Notes on Long-term Use	P.10
8. After-sales Service	P.11

The warranty only applies in the country of purchase.

**For
domestic
use**

- The product is not intended for commercial use.
- Do not use the product for anything other than its intended use according to the Instruction Manual. Doing so may result in unexpected accidents.



- Thank you for choosing our portable air purifier.
- Before using the product, thoroughly read this Instruction Manual for proper use.
- After reading, keep this manual in a safe place for quick reference.

1. Safety Precautions

Observe Strictly

● These Safety Precautions describe instructions that should be observed to prevent damage to property or injury to the customer or others using the product. Please read and comply with all of the instructions and warnings provided in this manual before using the product.

■ These instructions are divided into the following categories.

 Danger	This symbol indicates a potentially hazardous situation, which, if not avoided, could result in death, irreversible bodily injury and corresponding property damage.
 Warning	This symbol indicates a potentially hazardous situation, which, if not avoided, could result in bodily injury requiring medical attention and corresponding damage.
 Caution	This symbol indicates a potentially hazardous situation, which, if not avoided, may result in minor bodily injury and corresponding damage.

■ Explanation of graphic symbols used in this manual.



Indicates an action that is not allowed.



Indicates an action that must be done.



Danger



- Only for use as described in this manual.
- Do not disassemble, modify or repair this product.
- Do not subject it to impact, such as puncturing it with a nail, hitting it with hammer, or stepping on it.
- Do not throw the product into a fire or heat it.
- Do not splash with water or use in places subject to direct splashing with water.
- Do not connect or disconnect the USB cable with wet hands.
- Only use with the USB cable provided.
- Only use with the dedicated aroma capsule.
- Do not use or store the product within the reach of small children.
- Discontinue use of the aroma capsule if you are pregnant.
- Do not use the aroma capsule in a place where small animals are present.
- If you begin to feel unwell during use, discontinue use immediately.
- Do not adjust the product while driving.
- Do not install the product in a place in a car where it may obstruct visibility, hinder driving or endanger passengers.
- The product does not remove all harmful substances (e.g. carbon monoxide, etc.). Ensure adequate ventilation when using with a burner.
- When using with the strap attached, do not pull, entangle, swing, or throw the product. Also, do not store the product within reach of small children, people with dementia, or pets.
- Do not use the product in a space where flammable or explosive gases are present. Do not operate where aerosol (spray) products or pesticides are being used.



Danger



- Do not use or store the aroma capsule near fire.
- Discontinue use if you notice any abnormality such as smoke or an abnormal odour or noise.



- If you are wearing medical equipment, etc., check with the relevant medical equipment manufacturer before use.
- When using with the strap attached, be careful not to catch or pull it on a door or a protruding item.



To avoid serious injury or blindness due to leakage, rupture, heat generation, or ignition of rechargeable batteries, please be sure to observe the following precautions.



- If the liquid leaks, do not touch the liquid with your bare hands.
- If the leaked liquid gets into your eyes, do not rub, but after washing your eyes with water, immediately consult a doctor to avoid the risk of losing your eyesight.
- If the leaked liquid gets on your skin or clothes, after rinsing it off with clean water such as tap water, immediately consult a doctor.



Warning



- Do not allow foreign matter such as pins or wires enter the micro USB port, air inlet, air outlet or aroma capsule space.
- Do not use the USB cable if it is damaged or the connection is loose.
- Do not use or store the product near fire or in direct sunlight.



Caution



- Do not use or store the product outside the specified temperature range of 0°C to 40°C.
- Do not use or store the product outside the specified humidity range of 25% to 85% humidity.
- Do not install in a place subject to strong vibration or in unstable places.
- Do not use in places with a lot of oily smoke or dust.
- Do not store in an environment where it may come into contact with water.
- Do not damage, modify, bend, twist, or pull on the USB cable.
- This product generates negative ions, so inside of the product may be charged. You may get a shock by touching a metal part of the USB cable so please be careful.

2. Product Overview

【Main unit lid】

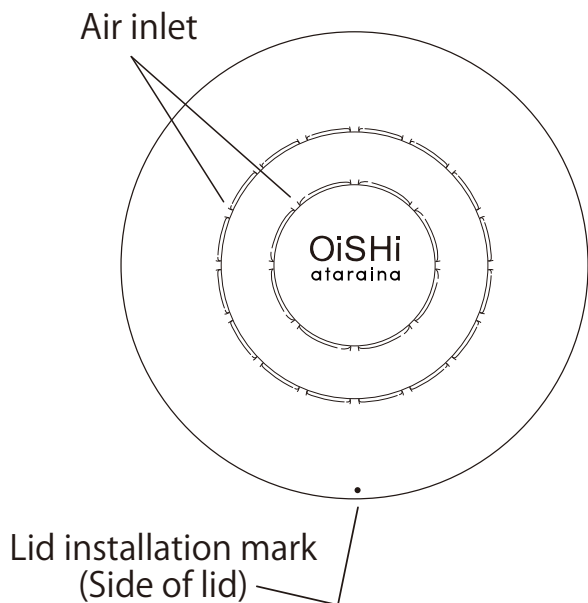

【Inside bottom of main unit】

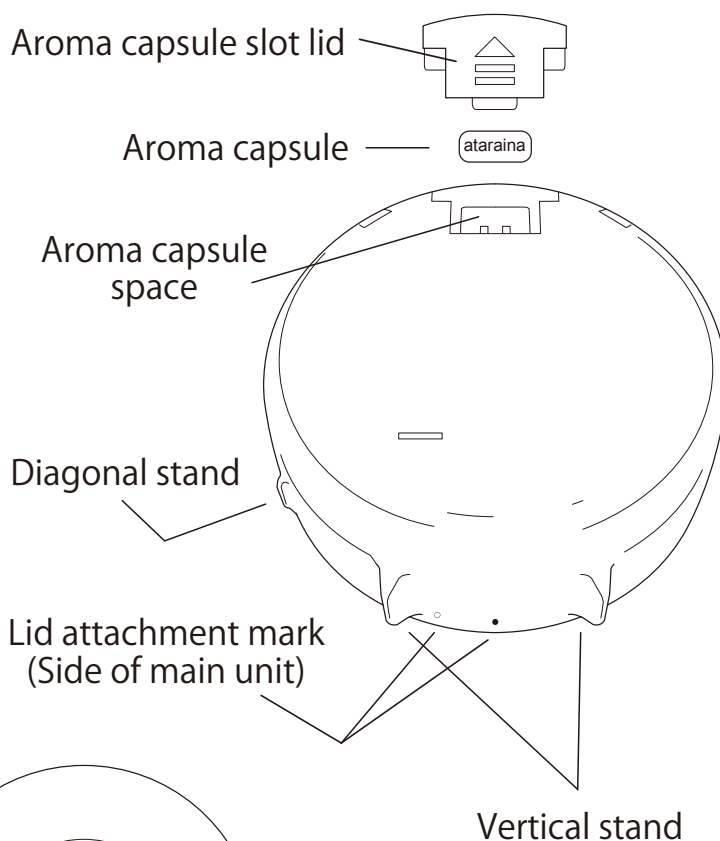

【Electrostatic filter】

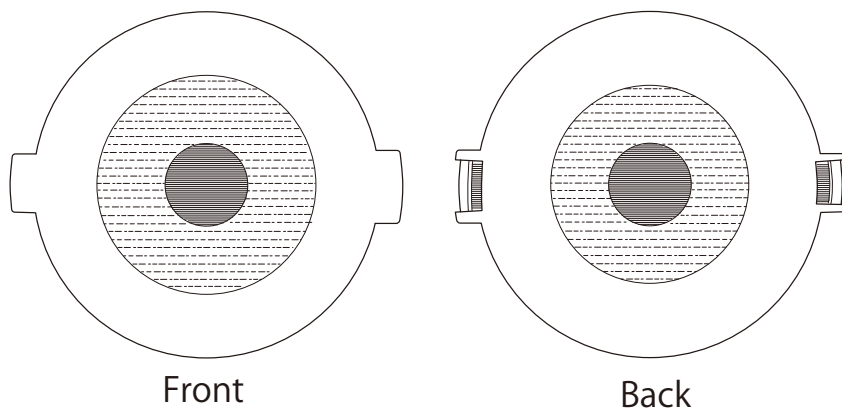

【Bottom of main unit】

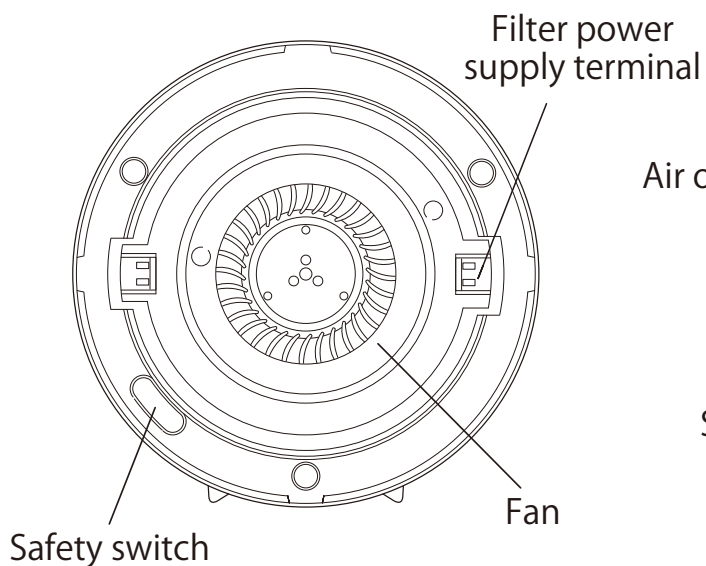

【Bottom side of main unit】

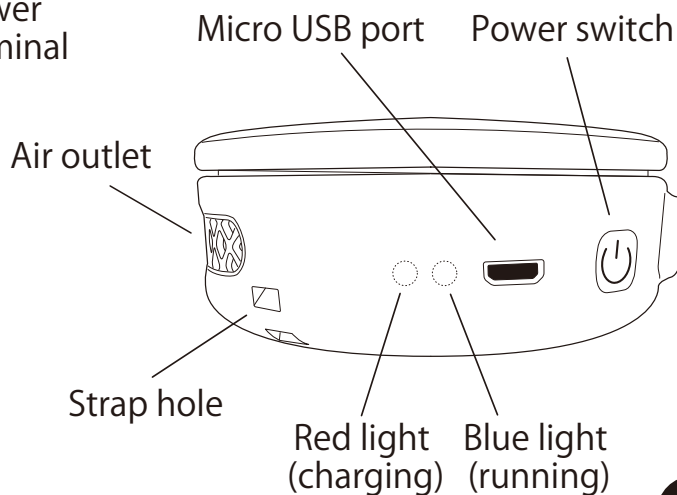

3. Operation

3-1. Getting started

1) Switch on and off

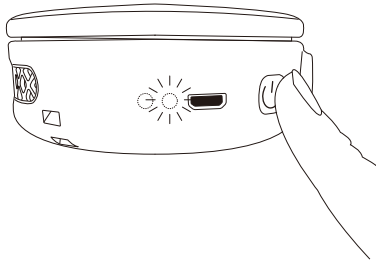

- ① After checking that the main unit cover is properly closed, press the power button to start the device. Fresh air and negative ions will be emitted from the air outlet.
→ The blue light will be illuminated. The blue light will stay on while the main unit is running.
- ② Tap the power switch again to turn the device off.
→ The blue light will go out.
- ③ When the charge is low, the blue light will flash and after 3 minutes the device will automatically turn off.
→ The blue light will go out.

2) Charging your device

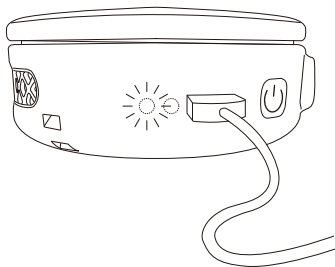

- ① Plug the included USB charging cable into the micro USB port to start charging the device.
→ The red light will illuminate.
※ You can continue to use the product while it is charging. In this case, both the blue and red lights will illuminate.
※ If the battery is fully charged (100% charged), the red light will not illuminate when the USB cable is plugged.
- ② When it is fully charged → The red light goes out.
※ The red light remains illuminated when the power is on, so please check with the power turned off.
※ The red light indicating charging status may not illuminate when the product is charged by the USB cable if the product is not used for an extended time. In this case, charge the product approximately a couple of minutes by the USB cable, and then the red light will illuminate.

3-2. Set-up

Always place on a stable desk or table with a flat surface.

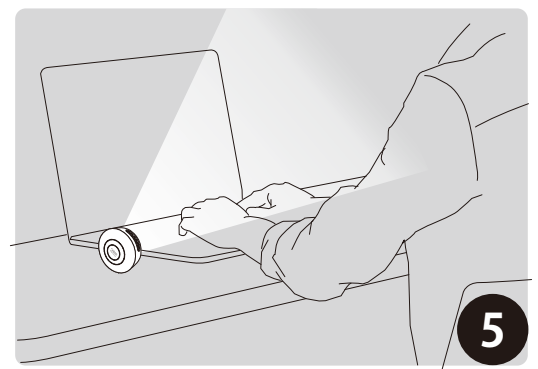
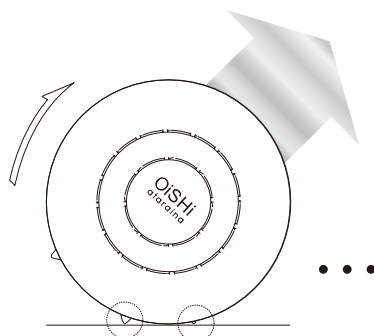

3-3. How to use when wearing around the neck

The OiSHi has holes (strap holes) for attaching straps. You can attach a strap here and hang it around your neck.

【How to attach】

1) Using a lobster clasp

Open the clasp, pass it through the strap hole, and close the clasp.

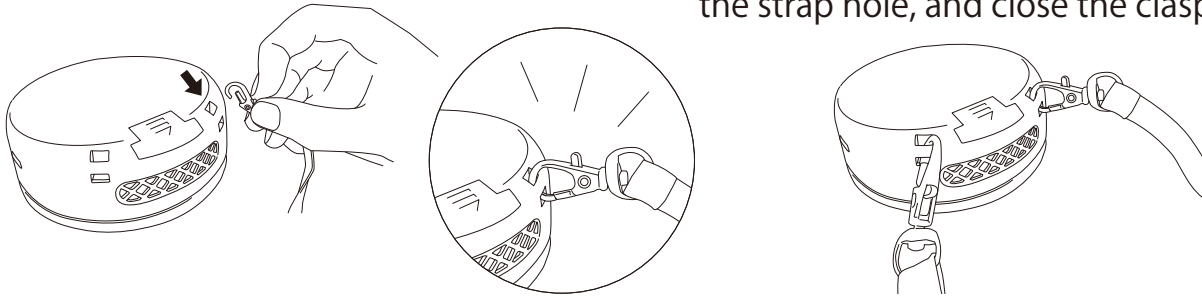

2) Using a quick release buckle

Pass the cord through the strap hole and pass the buckle through the loop. Pull to tighten.

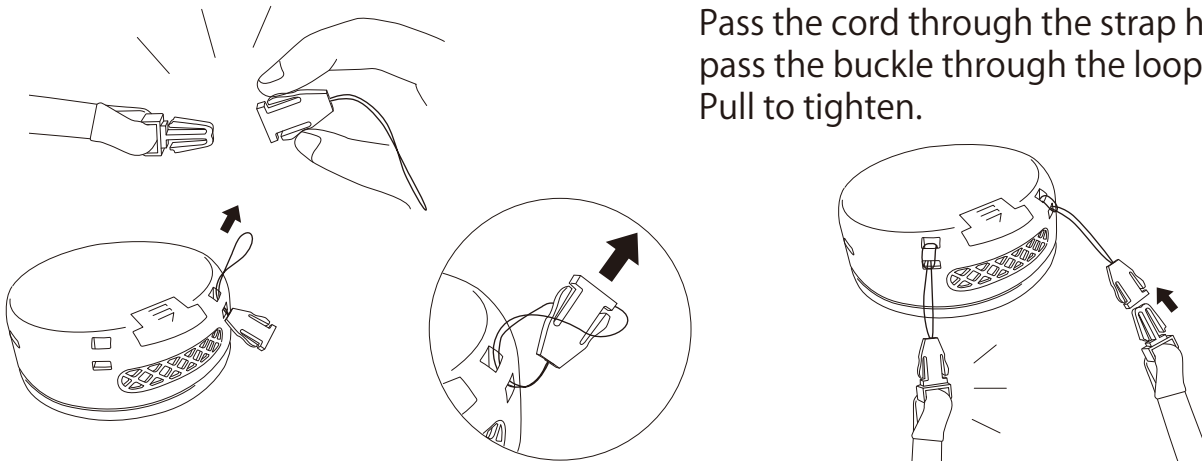

Precautions when using the strap



Danger

**Be sure to follow the precautions below.
Choking, injury, or product damage occurring.**

- Do not forcibly pull, wind, swing, or throw the main body or strap with the strap attached.
- Be careful not to get it caught in a door or a protruding object, or you may be pulled and choked by it.
- Do not store the product within reach of small children, people with dementia, or pets.

3-4. Replacing the Electrostatic Filter

- ① Turn the lid of the main unit in the direction of the arrow to remove it.
- ② Hold the electrostatic filter with the front side facing up and fit the filter into the bottom of the main unit.
- ③ Align the lid attachment mark on the side of the main unit and the lid attachment mark on the lid side as shown in the figure below, and turn them in the direction of the arrow.
- ④ Turn the lid until the installation marks match the same pattern. Finally, check that there is no gap between the lid and the bottom of the main unit and that the lid does not separate.

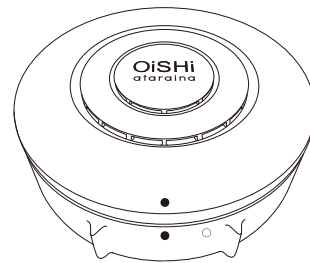
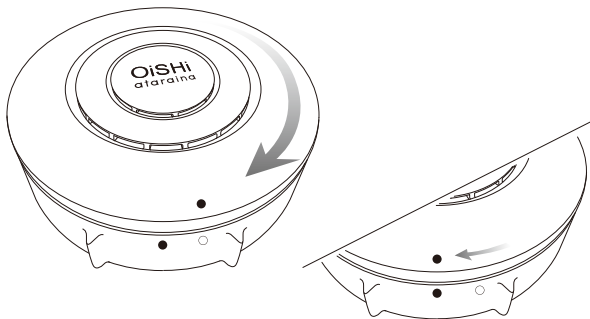
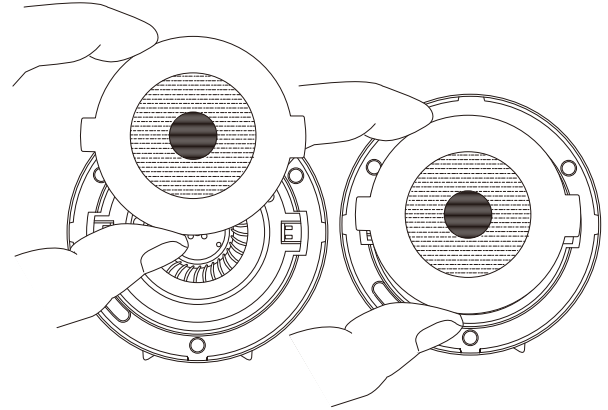
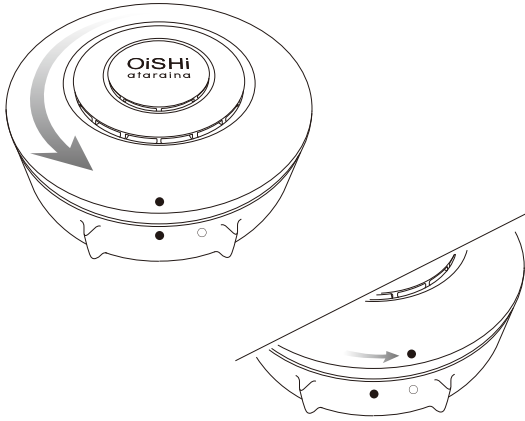

3-5. Inserting the Aroma Capsule

- ① Push the aroma capsule slot lid in the direction of the arrow.

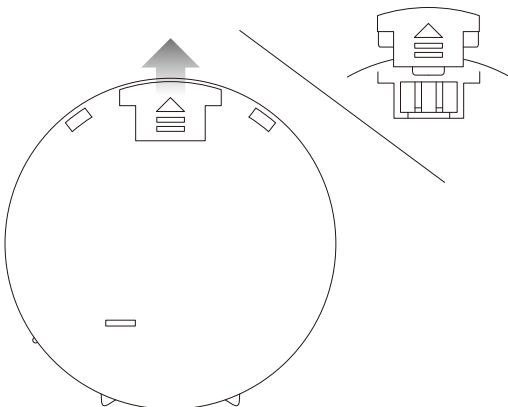

※ This product can be used as an air purifier without using an aroma capsule.

- ② Insert the aroma capsule and close the lid.

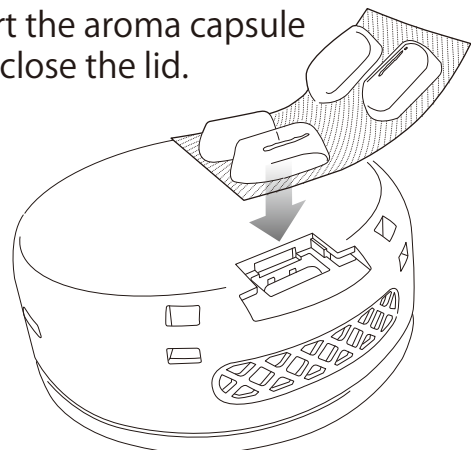

Before using the aroma capsule



- The aroma capsule together with the lid of the inlet are both very small. To prevent accidental ingestion, please use and store the product out of reach of people with dementia and children.
- Do not use the aroma capsule in a place where there is exposed fire such as in the kitchen.
- Do not put other aroma oils on the aroma capsule.
- Do not use products other than the dedicated aroma capsule.
- Do not use if you are pregnant.
- Refrain from using the aroma capsule in rooms with small animals such as pets.
- If you feel any discomfort due to the scent, stop using and ventilate the room.
- Pay attention to the health condition, constitution and sensitivity of the person using the product, and if any discomfort or abnormality is experienced, stop using it immediately.
- If the scent is strong during use, keep the OiSHi outlet away from your face. Also, ventilate the room if necessary.
- Aroma capsules are consumables. The scent may vary depending on the environment and personal preference. If the scent changes or becomes weak, replace the aroma capsule with a new one.
- Use the aroma capsule within the expiration date printed on the back of its packaging. The expiration date stated refers to unopened items. The capsule should be used as soon as possible after opening.
- Since it is a natural essential oil, its scent and colour may differ, but this is not an indication of a defect.
- Store the aroma capsule in a cool, dark place away from fire, direct sunlight, and hot and humid environments (they may cause the aroma to deteriorate).
- If you are being treated by a doctor or on prescribed medication, consult with the relevant medical institution before use.
- If you are an elderly person or have a previous medical condition, please try the scent first before using.
- For infants under 3 years old, please consider their physical condition and consult a doctor or an experienced specialist before use.
- If you have sensitive skin, or if you are using it for the first time, please try the scent first before using.
- If you have any abnormality on your skin such as inflammation, erythema or itching, please seek medical advice.
- When attaching the aroma capsule to the main unit, push the capsule case from above with your finger to attach it to the specified position, and close the lid completely. (Refer to P.7 Operation ("3-5. Inserting the Aroma Capsule"))

4. Specifications

【Product specifications】

Product name	: Portable air purifier OiSHi
Product number	: CT-OS01
Dimensions	: $\varphi 70 \times H 28$ mm
Weight	: Approximately 85 g
Material	: ABS
Ion generation rate	: Maximum 2 million ions/cc (outlet 20 cm)
Power supply	: Lithium-ion battery
Operating time	: Approximately 2 hours
Charging time	: Approximately 2 hours (when operation is stopped)
Filter replacement guideline	: 3 months (varies depending on the operating environment)
Aroma capsule replacement guideline	: 3 days (varies depending on usage environment and preferences).
Operating environment	: Temperature between 0°C to 40°C, Humidity between 25% to 85%
Recommended range of use	: 10 to 30 cm from the air outlet
Accessories	: 1 filter, 1 USB cable, 1 manual/warranty booklet 2 aroma capsule samples (natural plant extracts) ※The included aroma capsule is a sample product, so it may have discolouration or a weaker fragrance.

【Sold separately】

Replacement filter : CT-OS01-1-01

Replacement aroma capsule (Lavender) : CT-OS01-2-01

- ◇ Do not use any capsule other than the dedicated aroma capsule as it may cause malfunction.
- ◇ Please note that products are subject to change without notice.

5. Cleaning

【Taking care of the device】

1. Always unplug the device and disconnect the USB cable before cleaning.
2. Remove the lid of the main unit from the bottom of the main unit. (Refer to P.7 Operation (3-4. Replacing the Electrostatic Filter ①)).
3. Use a soft brush to remove dust that has accumulated on the lid inlet and main unit outlet.



- Be sure to disconnect the USB cable before cleaning.
- Do not use a brush made of hard material as it may damage the device.
- Using force may damage the device.
- Do not wipe the device with thinner, alcohol or benzene. It may cause a change in quality, discolouration or deterioration.



- Follow the precautions when using a chemical duster.
- Do not spray any flammable materials such as insecticides or fragrance around the device. It may cause a change in quality, discolouration or deterioration.

4. After cleaning, refer to P.7 Operation (3-4. Replacing the Electrostatic Filter ③,④).

6. Troubleshooting

The device is not working	<ul style="list-style-type: none"> ● Is the battery sufficiently charged? →Please try again after fully charging. ● Is the lid securely attached? →Turn it to the position of the arrow and attach it securely.
There is abnormal sound, heat, or vibration	<ul style="list-style-type: none"> ● Stop using immediately.
The air volume is weak	<ul style="list-style-type: none"> ● Is there dust accumulated on the inlet, outlet, or filter of the lid? →Use a soft brush to remove dust from the air inlet and outlet of the lid and replace the filter with a new one.

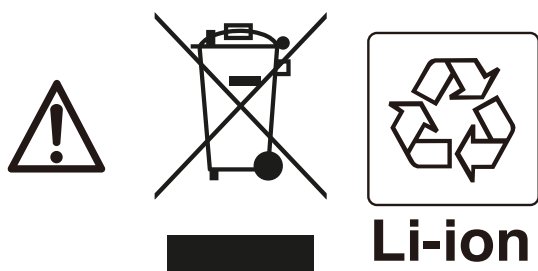

How to dispose of the product

Batteries and electronic components are used in this product, so please dispose of them at a recycling centre.

If you have any questions, please contact the waste disposal service in your area or the store of purchase.

7. Notes on Long-term Use

If used for a long period of time, the internal parts may deteriorate due to heat, moisture, dust, etc., and smoke or fire may occur. If any of the following occurs during use, turn off the power switch, disconnect the USB cable, and contact the store of purchase or the Customer Support Centre outlined in this manual.

With Long-term Use...

- ◆ The fan does not turn on even when the switch is turned on (there is no wind).
- ◆ The fan is rotating slowly. / The operation is irregular.
- ◆ Abnormal noise or vibration occurs when the fan rotates.
- ◆ The product is unusually hot or has a burning odour.
- ◆ The USB cord is broken, bent, or damaged.

If you find any abnormalities, discontinue use immediately!

Immediately turn off the power switch, disconnect the USB cable, and contact the store of purchase or the Customer Support Centre outlined in this manual.

8. After-sales Service

- ① This product comes with a warranty. At the store of purchase, ensure the retailer enters the date of purchase and store stamp on the warranty.
- ② The warranty period is for one year from the date of purchase. For repairs during the warranty period, please contact the store of purchase. Repairs will be carried out in accordance with the warranty. Please see the warranty for further details.
- ③ For repairs (chargeable) after the expiration of the warranty period, please contact the store of purchase.
- ④ The holding period for repair parts for this product is 6 years after production is discontinued. Repair parts are parts that are necessary to maintain the functionality of the product.
- ⑤ Should you have any questions regarding our after-sales service, feel free to contact our Customer Support Centre using the contact details outlined in this manual.

【Exemptions】

- ▲ The Company is not liable for any damages arising from earthquakes, fires, actions by third parties, other accidents, intentional or mistaken operation by the customer, or use under other unusual conditions outside the responsibility of the Company.
- ▲ The Company is not liable for any incidental damages (loss of business income, disruption of business, damage to objects etc.) arising from the use of or inability to use the product.
- ▲ The Company is not liable for any damages arising from failure to observe the described content of the Instruction Manual.
- ▲ In all cases, the Company will bear the cost of this product within the price of the product.

【Warranty Provisions】

- In the unlikely event that a failure occurs during normal use in accordance with the Instruction Manual and Safety Precautions, the Company will repair or replace the device free of charge within one year from the date of purchase.
- Even within the warranty period, the following cases are not covered by the warranty.
 - A. Misuse, improper repair, modification, or damage.
 - B. Fault or damage due to dropping after purchase.
 - C. Fault or damage due to fire, earthquake, water damage, lightning strike, gas damage, salt damage and other natural disasters, pollution or an abnormal voltage.
 - D. No warranty card presented.
 - E. The date of purchase and the name of the store are not entered on the warranty card or the warranty card has been modified.
 - F. The warranty is claimed outside the country of purchase.
 - G. Deterioration due to normal wear and tear.
- The warranty will not be reissued, so please keep it in a safe place so as not to lose it.
- Please get in touch with our Customer Support Centre for advice on handling and caring for the device or if you are having trouble contacting the distributor for repairs due to relocating or the product being a gift item.
- We also accept enquiries by email. In that case, please include the product name, product number, content of query, your name, phone number and store of purchase.

Customer Support Centre : Creative Trading Co., Ltd.
For e-mail enquiries, contact epica@createch.co.jp

Handling of personal information

Creative Trading Co., Ltd. and its affiliates may use and keep records of the personal information of customers and the content of queries for the purpose of responding to queries, arranging repairs or sending confirmations. Personal information will not be provided to a third party unless it is properly managed and outsourced for repair work or where there are other legitimate reasons.

Warranty

This document entitles the customer to free repairs under the warranty provisions of this document, in the event of a failure within the following period from the date of purchase.

Product name	Portable air purifier OiSHi	Model number	CT-OS01
Warranty period	1 year from the date of purchase		
Date of purchase		Distributor name	
Customer	Name	Address	

- Thank you for choosing our portable air purifier.
- Before using the product, thoroughly read this Instruction Manual for proper use.
- After reading, keep this manual in a safe place for quick reference.

**You can also download the
Instruction Manual here. ►**

